



## Orb

### Design by Senator

Why are desks rectangular, when much of human culture in terms of shape and form is round? Orb is a revolutionary desking solution that allows the

liberalisation of space through 360 degree circular worktops. We're not talking simply about cutting corners, far from it, Orb's design permits a natural

fluidity to the workspace allowing gentle crescents to be created through the simple interlocking of workstations.

## DIMENSIONS

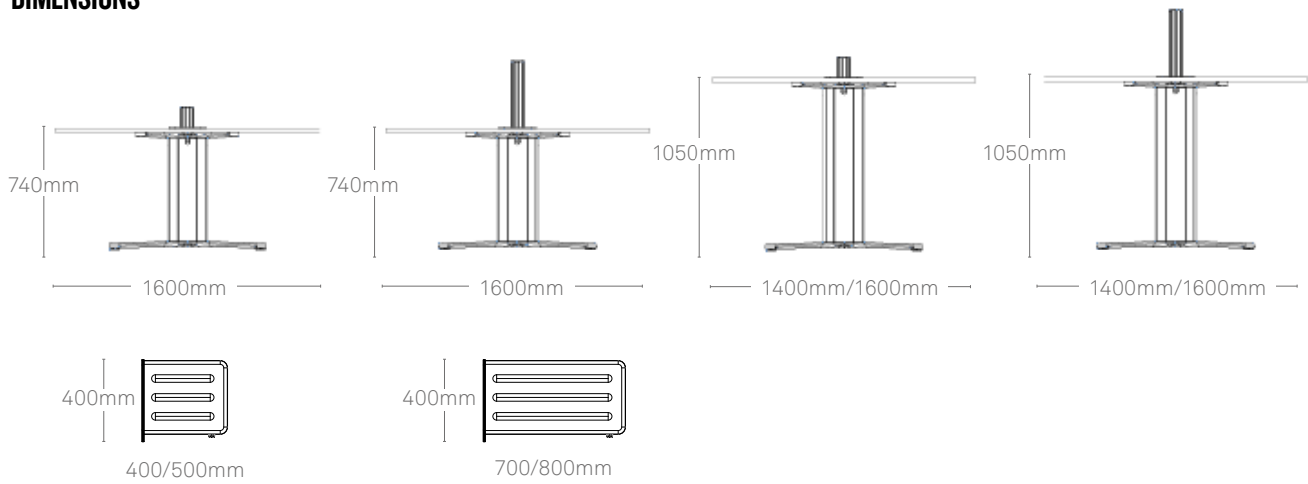

## TECHNICAL INFORMATION

### Standard Features

- 4 star cast aluminium base
- Aluminium extruded column
- Aluminium levelling feet
- 4 star cast aluminium top mounting
- Aluminium cable port with lift off covers

### Specifiable Features

- 740mm or 1050mm high
- 1600 dia circular or 1600 dia bite
- 1400 dia circular or 1400 dia bite (1050mm only)
- Full height or low height post
- 25mm MFC top
- 25mm MFMDf top with a ref 45. cutback edge profile

### Complementary Options

- Full screen
- Bite screen
- Above desk power/USB power
- Under desk power with vertical cable management
- Ply effect contrast edging
- MFMDf edge profile can be stained

### Accessories

- CPU holders
- Monitor arms
- Desk top accessories
- Single and double arm pendant light

### Performance Standards

- BSEN 527, Part 1, 2011
- BSEN 527, Part 2:2002
- BSEN 527, Part 3:2003
- BSEN 9241 Part 5, 1999
- BS 6396:2008

## Orb

Round 1600

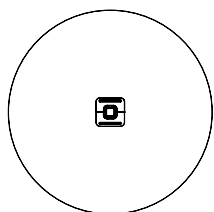

1600mm

Bite 1600

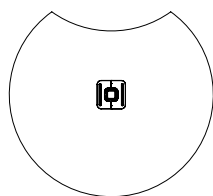

1600mm

Round 1400\*

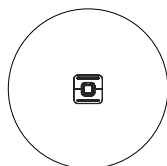

1400mm

Bite 1400\*

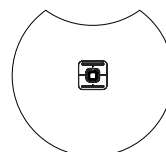

1400mm

\*1400 only available on 1050mm height

## ACCESSORIES

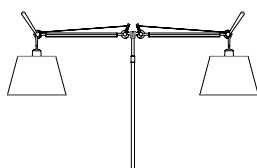

Orb  
Dual Light

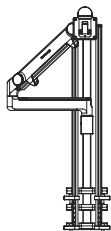

M2  
Monitor Arm

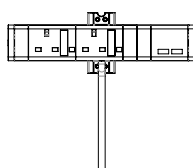

Orb Above Power  
Desk Light



Orb  
CPU Holder

# Orb

Straight

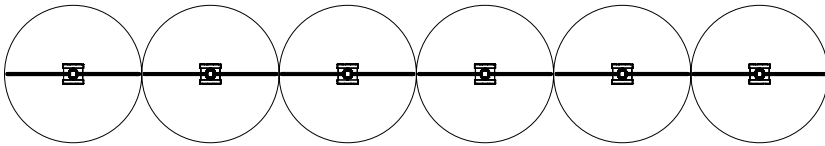

Straight with bite

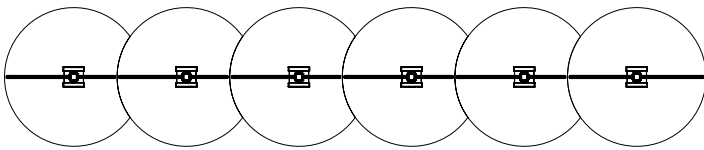

Curve

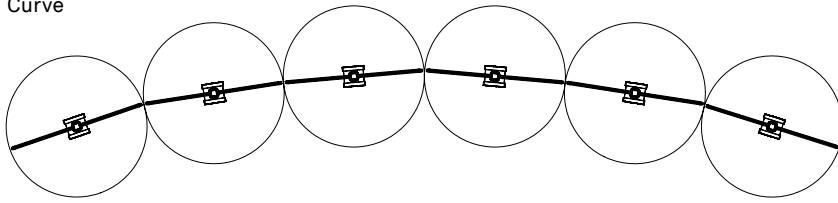

Curve with bite

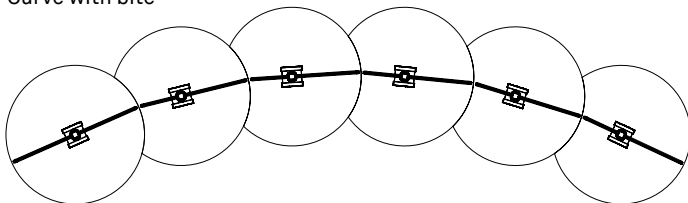

Spine

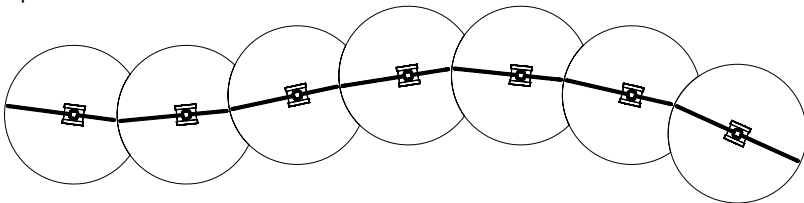

Offset

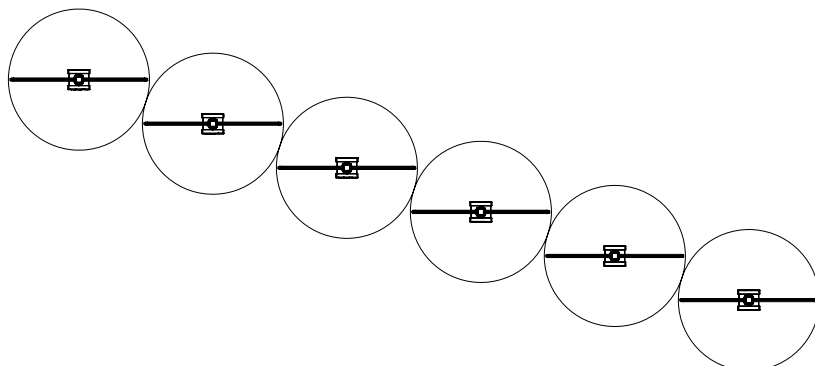

**MFC/MFMDF FINISHES**

A wide choice of A-range laminates are also available



**LINOLEUM**

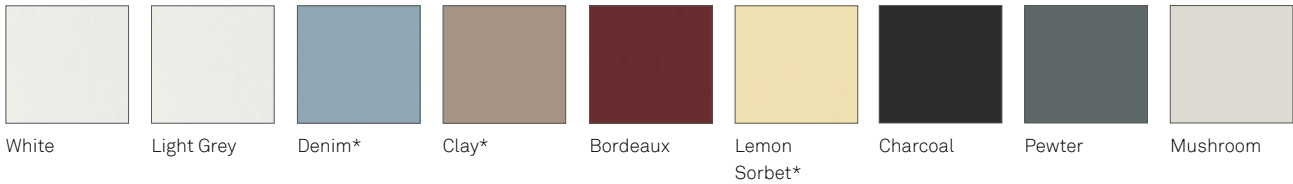

**GRADE B MFMDF FINISHES**



**CONTRAST EDGING FINISHES**

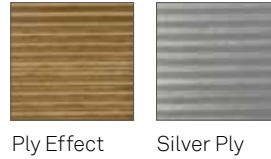

**FRAME FINISHES**



\* Selected models only

**ENVIRONMENTAL**

**Material Content**

Components are constructed of the following

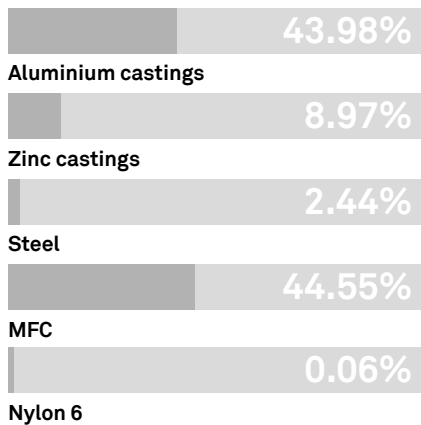

**Recycled Content**

Contains up to 47% of Recycled Material

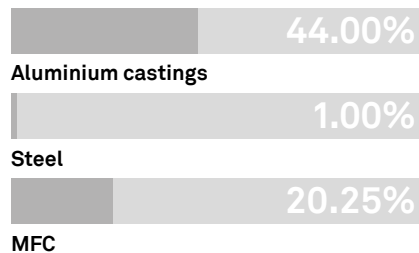

**Recyclability**

The range is 99% recyclable

**99%**

**SKA Accreditation**

EPA's to ISO14025, FSC and FISP accreditation are available for all products on request.