

# CHEMISTRY CANOPY

A welcome addition to Senator's Chemistry range is Chemistry Canopy. Canopy's soft and open design creates an inviting work area that has the correct balance of privacy, without a feeling of isolation.

A complement to Chemistry desking, Canopy's fabric covered panels with optional tech knit pockets can be used to pin and store inspirational materials. A magnetic dry wipe board both inside and outside makes clever use of the space.

**bhc furniture**  
plan - manage - install

BHC Furniture, 1 St Mark Street, London. E1 8DA  
Tel - 0207 264 1945  
Fax - 0207 264 1947

# Welcome to the Chemistry Canopy list

## PRICE LIST INTRODUCTION

A welcome addition to Senator's Chemistry range is Chemistry Canopy. Canopy's soft and open design creates an inviting work area that has the correct balance of privacy, without a feeling of isolation.

A complement to Chemistry desking, Canopy's fabric covered panels with optional tech knit pockets can be used to pin and store inspirational materials. A magnetic dry wipe board both inside and outside makes clever use of the space.

## CHEMISTRY CANOPY - Product Specification

### Standard Features

- Extruded Aluminium rails
- Cast Aluminium connector joints
- Steel stabilising feet
- Fabric wrapped acoustic panels
- Magnetic dry wipe panel (dual sided)
- Luminated light with surface mounted switch
- Modular retro fitable design

### Specifiable Features

- Single Canopy
- Double Canopy
- Back to back Canopy
- Tech knit Stretch pockets for storage

## DIMENSIONS

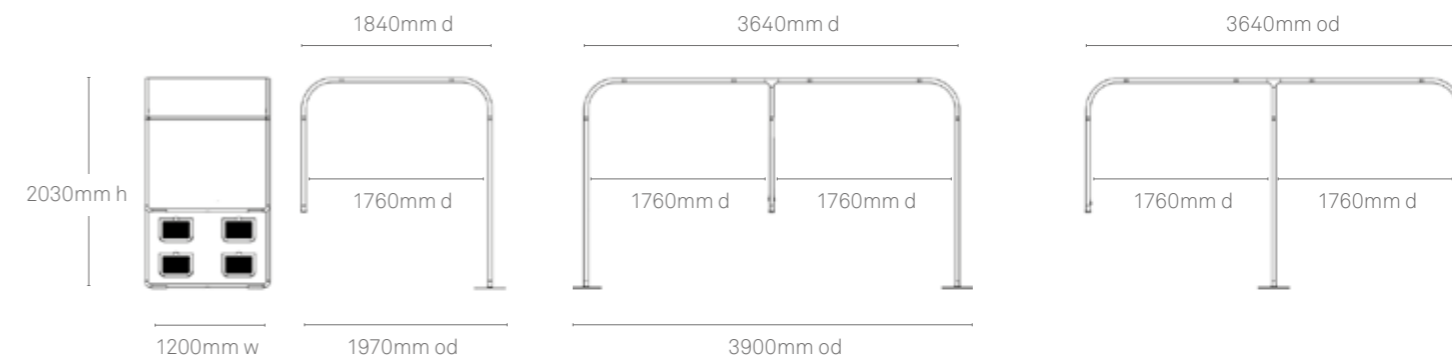

### Material Content

Components are constructed of the following

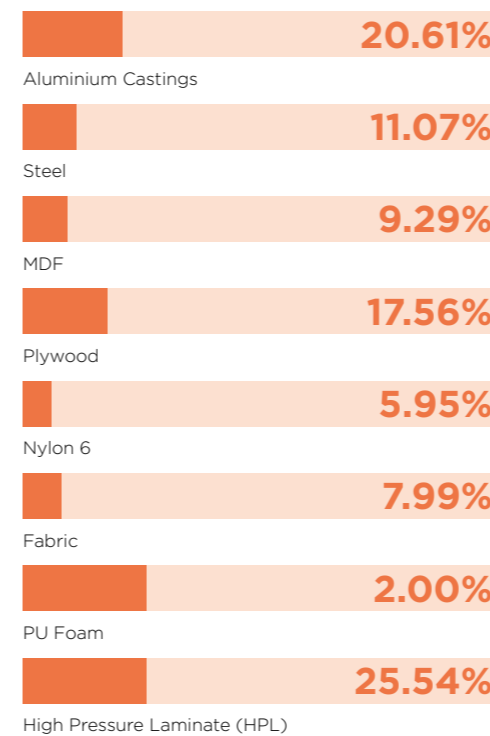

### Recycled Content

Contains up to 34.55% of Recycled Material

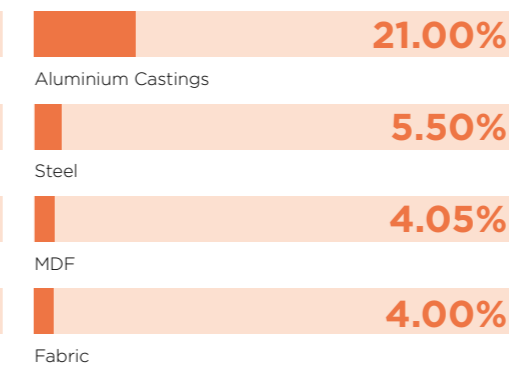

### Recyclability

The range is 99% recyclable

99%

Chemistry Canopy – Statement of Line

● Available  
□ Not available

Single Canopy  
1200mm Width



Single Add On End  
800mm Depth Storage



Depth (mm)	1840
2030mm h	●

For detail see pages S358. Please refer to pages S360 for prices.  
Desk Sold Separately

Double Canopy  
1200mm Width



Depth (mm)	3640
2030mm h	●

For detail see pages S358. Please refer to pages S360 for prices.  
Desk Sold Separately

Back to Back Canopy  
1200mm Width



Depth (mm)	3640
2030mm h	●

For detail see pages S358. Please refer to pages S360 for prices.  
Desk Sold Separately

Chemistry Canopy – Product Detail

Chemistry Canopy is a new addition to the Chemistry range, designed to be an acoustic setting for open office spaces for quiet working or interactive meetings.



Features

Mounting brackets

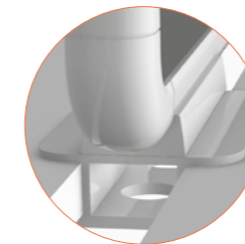

Modular fixing to the desk.

Lighting

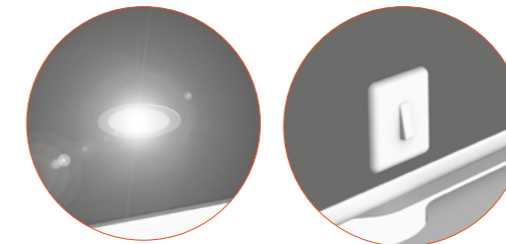

Canopy features plug and play lighting with easily accessible surface mounted switch.

Magnetic dry wipe board

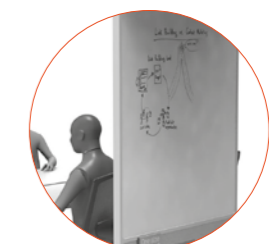

Magnetic dry wipe on both faces.

Acoustic panels



Canopy's panels are designed to effectively absorb sound and provide sound insulation, creating an environment that promotes quiet work in an open plan office.

Foot plate

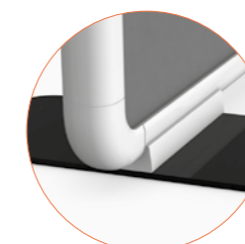

Stabilising 10mm steel plate feet provide rigid stability.

Options

Storage pockets

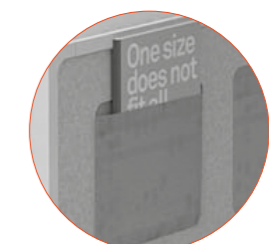

Stretch Tech knit Pockets for storage  
CPY01 is supplied with 4 pockets  
CPY02/03 are supplied with 8 pockets

## Chemistry Canopy – Construction

Chemistry Canopy consists of several sub-frames. Each sub-frame is delivered pre-assembled for ease of installation.

Chemistry Canopy sub-frames can be dropped into place and locked in position using bolts provided. Push fit moulded caps are supplied to cover the fixtures and fittings.

